

Rail systems

Portofino
Capri

Pergola
Awnings

Just
enjoy life!

Lewens
MARKISEN

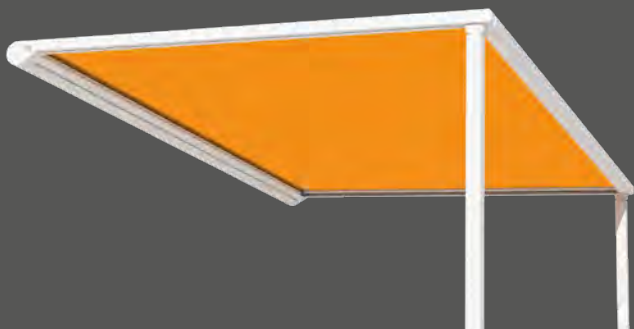



Space for living

Pergola awnings are extremely popular, creating space for quality outdoor living. The awning casing, guide tracks and free-standing uprights form a sturdy frame structure. This makes the sunshade especially windproof. The uprights also significantly reduce the loading on the mounting wall, which is advantageous for insulated facades in particular. Pergolas from Lewens have been specially developed to meet particular demands in respect of technology, design and finishing. Available in a wide variety of models, they combine reliability with convenient operation. Meticulous workmanship and superb materials guarantee the longevity of the products.

For 25 years, Ludwigslust-based company Lewens has been manufacturing a wide range of high-quality, custom-made awning and glass roof systems in a full-service operation extending from design via making-up to assembly.

Skilled specialist dealers provide advice and handle sales, installation and maintenance on site. This ensures proximity to the customer and optimum service so that you, the customer, can just enjoy life!



Quality "made in Germany":

*all awnings and glass roofs from Lewens
are manufactured in Germany.*



Just
enjoy life!



Portofino



4



6

Capri

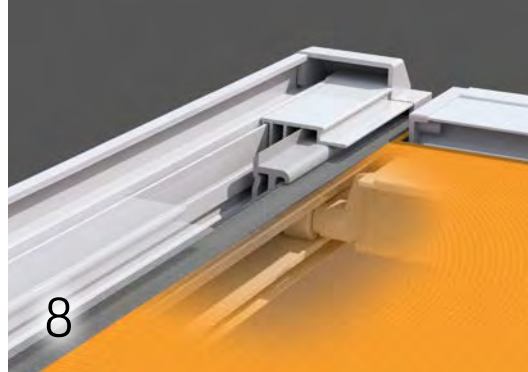

8

Quality and technology



10

Comfort options



Contents

Models

Portofino 4
Pergola awning
with zip awning guide

Capri 6
Pergola awning with
variable track positioning

Equipment

Quality and technology 8
Focus on function and
workmanship

Comfort options 10
Vario valance, Vario uprights,
electrics and wireless

Fabrics and colours 12
Fabric collection and
choice of frame colours

Technical data 14
at a glance

To match

Micro 700 15
Side screen awning



Portofino Pergola type

An exciting and versatile performer



4

When the sun is low in the sky, the optional **Vario valance** offers a sunshade and privacy screen that can be adjusted as required.

Height-adjustable **Vario uprights** (option) offer variable shade and facilitate instant run-off during light showers.

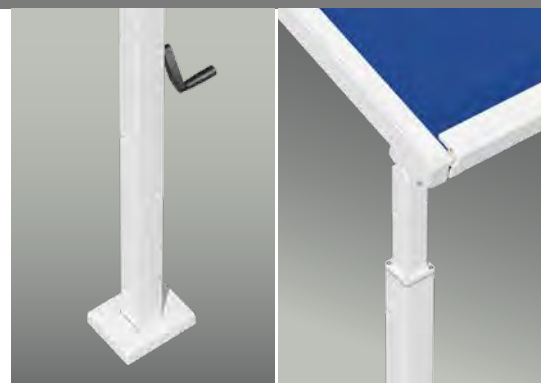

Equipment and convenience features

- Width, 1 unit max. 600 cm, double unit max. 1200 cm, drop max. 500 cm
- Zip guide and patented balance spring technology
- Electric motor
- Options:
Radio motor/radio remote control, automatic weather sensor, LED lighting (*strip integrated into casing, profiles below guide tracks, LED uprights*), radiant heater, Vario valance, Vario uprights



As a patio awning with free-standing uprights, the Portofino type pergola is a particularly windproof sunshade model. Thanks to its closed zip guide, the awning is always perfectly tensioned, offering good looks teamed with complete shade from the sun. For greater flexibility and comfort on the patio, the Portofino also comes with Vario uprights, enabling the front corners to be lowered for variable shade and relaxed, highly indulgent outdoor living.

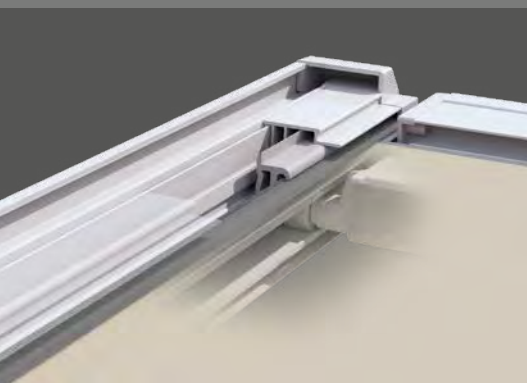

Fabric guide **ZIP**

The track systems, which have received recognition with the GDA Aluminium Profile Award, are equipped with a zip guide and patented balance spring technology. These ensure a taut sit of the fabric, greater wind safety and complete shade from the sun.

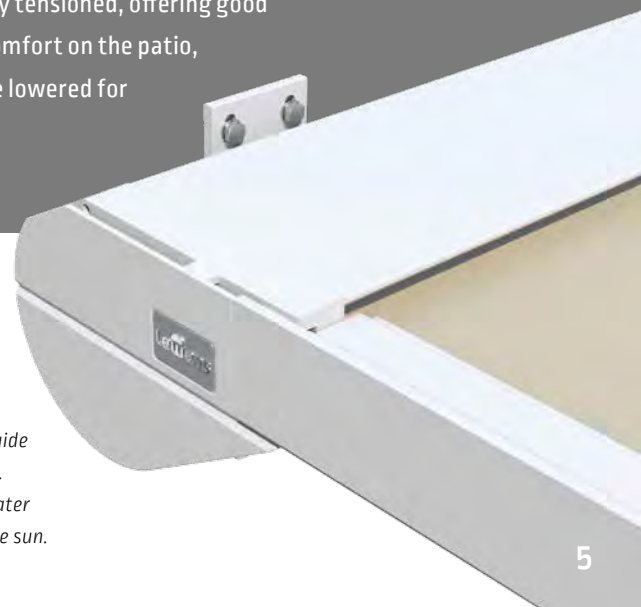



*Capri Pergola type:
sturdy and decorative
as a patio sunshade*

Capri Pergola type

Patio awning with flexible guide positioning



Pergola type

The Capri is a particularly sturdy form of pergola awning for the patio. The tracks and uprights can be positioned variably as required.



Equipment and extras

- Width, 1 unit max. 600 cm, drop max. 600 cm
- Electric motor
- Options:
Radio motor/
radio remote control,
automatic weather sensor,
LED lighting [LED uprights]
radiant heater



Installed in front of a house or terrace wall, the Capri type pergola combines the lightness of a fabric sunshade with the appearance of a patio roof. The free-standing uprights render the pergola awning an extremely windproof sunshade design.

A particular highlight is the option of mounting the guide tracks and uprights moved inwards to suit the conditions of the structure and site.

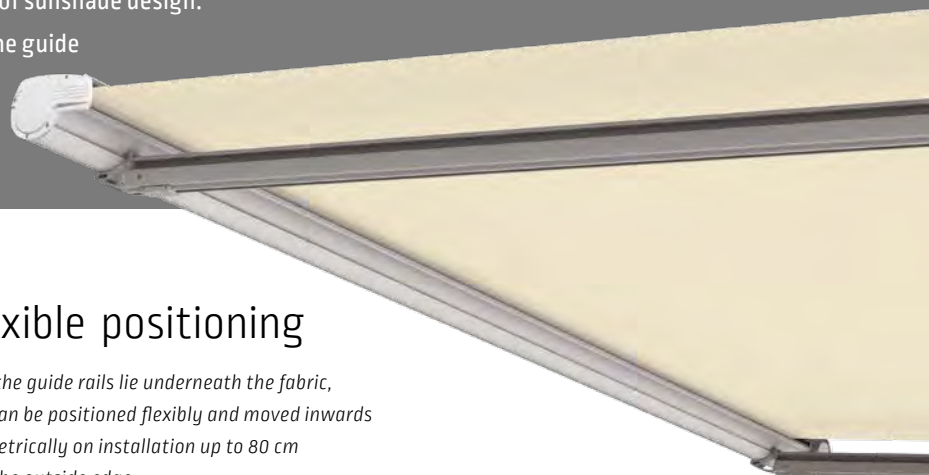

Flexible positioning

Since the guide rails lie underneath the fabric, they can be positioned flexibly and moved inwards symmetrically on installation up to 80 cm from the outside edge.



External + zip

On the **Portofino** awning, the guide rails are likewise in the fabric plane and externally on the sides of the awning fabric. The zip guide holds the fabric perfectly in shape and position.



Recessed

Since the guide rails on the **Capri** awning lie underneath the fabric, they can be positioned flexibly and moved inwards symmetrically on installation up to 80 cm from the outside edge.

Quality and technology made in Germany

Based on reliable and proven technology and with intelligently designed details, rail systems from Lewens make a convincing impression due to their ease of operation and flexible installation options. Centimetre-accurate manufacturing, even in intermediate sizes, ensures a perfect fit in virtually any desired location.

Award-winning

For its highly accurate, easy to assemble rail systems, the **Portofino** awning won the **GDA Aluminium Profile Award** of the Gesamtverband der Aluminiumindustrie e.V., the German aluminium industry association. It was also recognised with the **German Design Award 2022 in gold**, with the **iF Design Award 2022** and with the **ADC Award 2022** for its successful combination of outstanding design and innovative technology.



A look at the components in the side rails shows the interaction of the traction cable and spring when the front profile is extended.

Portofino:

The zip fabric guide and patented balancing spring technology ensure a taut sit of the fabric and complete shade from the sun.

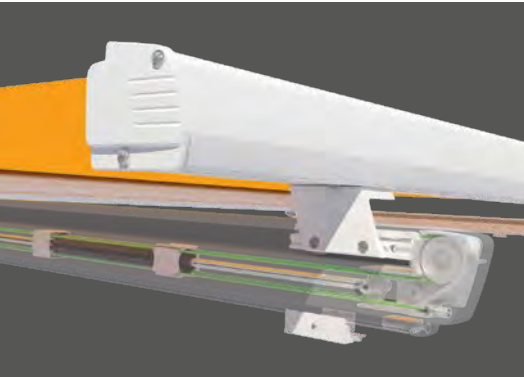
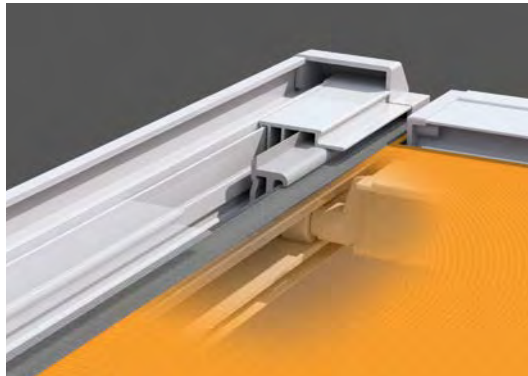

Capri:

The carriage is supported in needle roller bearings for quiet operation of the front profile.

The **track holders** securely connect the tracks and uprights and in doing so balance out the pitch angle of the pergola awning.



Symmetrical (standard)



Asymmetrical (option),
e.g. for niche installation

Ground attachment

On concrete bases, the **bottom consoles** are attached by threaded bolts and covered by caps in the frame colour. On less firm substrates, screwed foundations can be used as an alternative.

In the case of large awning formats, the Capri model is supplied with a **fabric support**, as the weight of the awning fabric may cause the fabric to sag in the middle.

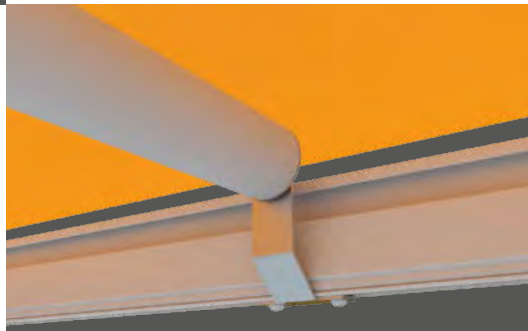

Capri

Guaranteed
quality



Quality and production
to CE standard:

Look out for the mark
guaranteeing the quality
and technical safety
of our products.



Branded goods from Germany:

Lewens awnings are manu-
factured and assembled in
Germany –
quality “made in Germany”!



Vario valance

Standard equipment

- Supplied as standard with crank operation and acrylic awning fabric
- Hanging heights: 150 and 175 cm

Add-on features *(incur an extra charge)*

- Polyester fabric (valance lengths 150 and 175 cm), Soltis 92 (valance length approx. 160 cm), Orchestra MAX (valance length 150 cm)
- Solar-powered Somfy io motor: valance length then 150 cm in acrylic/polyester, 160 cm in Soltis 92, 120 cm in Orchestra MAX

Not in combination with radiant heater.

Options

Portofino

The **Vario Valance** offers variable shade and privacy while retaining the headroom below the awning. When the awning is retracted, the Vario Valance can also be used as a window blind, creating shade and a cool climate inside. **Vario uprights** offer the option of lowering the front corners of the pergola awning. This enables the privacy screen to be adjusted flexibly, while light showers are quickly drained off.

Vario uprights

The Portofino pergola is equipped as standard with fixed-height uprights (figure left). One or two height-adjustable Vario uprights can be optionally selected (figure right).

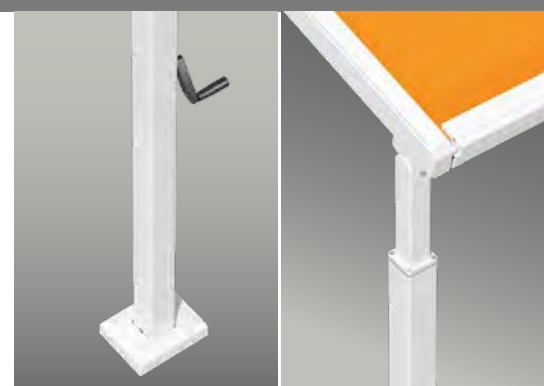



Radio controllers

create the prerequisites for integrating all patio functions into the home automation system, with convenient operation by tablet or smartphone.



Automatic weather sensor

Sun and wind monitors and wind sensors ensure automatic, weather-dependent control of awnings – even when there's no one at home.

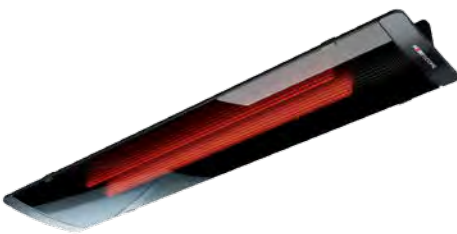

Infrared radiant heaters

create a cosy atmosphere and pleasant warmth under awnings and glass roofs, even on chilly days.



LED profile
[Portofino]

Options

Electrical

Want more than the wall switch for operation and other comfort features too? Then you have the choice of radio control systems, radiant heater and automatic weather sensor components meeting the current standard, which can be integrated into the home automation system.

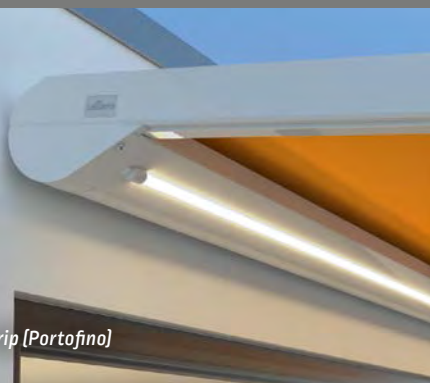

LED strip [Portofino]

LED lighting

Equipped with a radio receiver (option), suitable mood lighting for any situation can be created by remote control or via the home automation system.



LED upright
[Portofino, Capri]

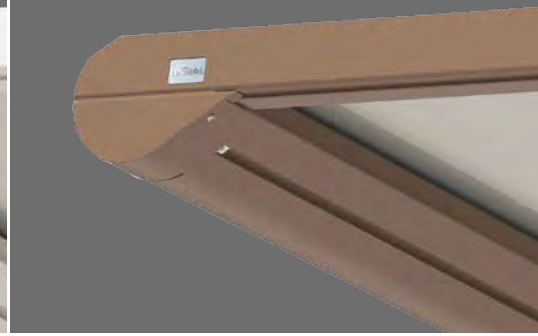
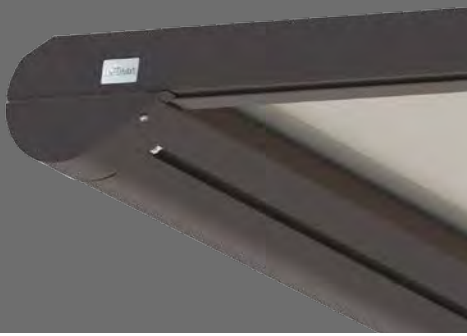

Standard colours: RAL colours and textured finishes (SL) at no extra charge



Frame colours to order

The frames of Lewens glass roofs and awnings are given a high-grade powder coating, rendering them particularly UV- and weather-resistant. Hundreds of RAL colours and textured finishes (SL) are available to choose from, including a wide range of contemporary colours offered as standard at no extra charge.

Preanodising (optional):

An optional preanodising treatment increases the durability of the coating for products used in coastal regions in particular. This can be selected when ordering.



Colour deviations are possible due to the printing process used.

The Lewens collection offers you high-quality acrylic and polyester fabrics that are solution-dyed to retain their colour brilliance for longer, wovens containing 85% recycled polyester from PET bottles as well as partly transparent glass fibre screen fabrics and Soltis 92.

Lewens awning fabrics have been created especially for use outdoors and are treated to make them water- and dirt-repellent. We make the awnings up using the latest sewing techniques for distortion-free seams and also using ultrasonic bonding. We have designed our manufacturing facility so that the awning fabrics can be laid out entirely flat (not folded) for making up.

Some of our quality features:

- Secure lockstitch used for making up, optionally also with ultrasonically bonded seam (surcharge).
- Awning and valance are produced from one piece (identical repeat pattern)
- Seams on top and bottom and valance seam neatened (clean completion)
- Repeat-symmetrical completion left and right
- Use of Tenara® quality sewing yarn (also for valances)

The Collection

Fabrics ranging
from modern to classic

*For Vario Valances,
the choice of **Soltis 92
woven fabric** is recommended,
which provides protection from the sun
and glare while affording
a view outwards.*

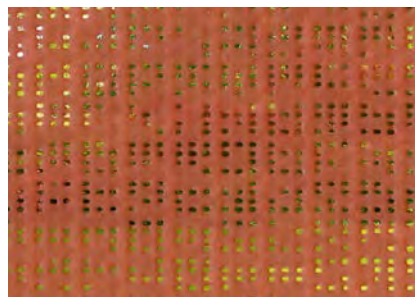

Pergola awnings

Equipment and technical features



Manufactured and assembled in Germany
TÜV-tested safety (Portofino)
Quality and technology CE-compliant

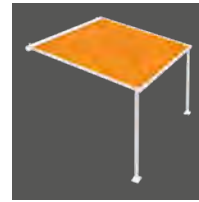

Portofino

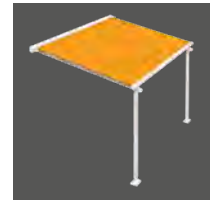

Capri

Type	Pergola	Pergola
Fabric guide	ZIP	Open
System height	152 mm	223 mm
Upright height <i>(for adjustment on site)</i>	250 cm ■	250 cm ■
Special upright heights	<input type="checkbox"/>	<input type="checkbox"/>
Unit widths <i>(max.)</i>		
1 unit <i>(single field)</i>	600 cm	600 cm
2 part <i>(double unit: 2 cassettes, 2 motors, 4 guide rails, 3 uprights)</i>	1.200 cm	–
Drop <i>(max.)</i>		
Depth <i>(incl. cassette, on Capri plus 11 cm return roller)</i>	500 cm	600 cm
Upright distance from wall <i>(max.)</i>	400 cm	500 cm
Upright recess at front <i>(max., depends on unit depth!)</i>	100 cm	100 cm
Lateral recess		
Recess <i>(guide tracks with uprights)</i>	–	up to W 550 cm: ■ 25 cm from W 551 cm: ■ 40 cm
<i>(other) inward positioning on request <i>(indicate when ordering)</i></i>	–	<input type="checkbox"/> max. 80 cm
Drive		
Electric motor <i>(for wall switch)</i>	■	■
Radio motor	<input type="checkbox"/>	<input type="checkbox"/>
Frame colours		
29 Lewens standard frame colours	■	■
Additional RAL, special colours and effect finishes	<input type="checkbox"/>	<input type="checkbox"/>
Awning fabrics <i>from the LEWENS collection</i>		
Branded acrylic <i>(spun-dyed, ultra fade resistant)</i>	■	■
Branded polyester/recycled polyester <i>(spun-dyed, ultra fade resistant)</i>	<input type="checkbox"/>	<input type="checkbox"/>
Orchestra MAX <i>(branded acrylic, water repellent)</i>	<input type="checkbox"/>	–
Tenara quality sewing yarn	■	■
Options		
1 Radio motor + radio remote control	<input type="checkbox"/>	<input type="checkbox"/>
2 Automatic weather sensor <i>(sund,wind, rain)</i>	<input type="checkbox"/>	<input type="checkbox"/>
3 Lighting – LED upright(s) – integral LED strip, LED profile	<input type="checkbox"/>	<input type="checkbox"/>
4 Radiant heater <i>(only wall attachment)</i>	<input type="checkbox"/>	<input type="checkbox"/>
5 Vario valance <i>(not with 4)</i>	<input type="checkbox"/>	–
6 Solar radio motor <i>(Somfy io) only for Vario valance (5)</i>	<input type="checkbox"/>	–
7 Vario upright(s), upright lowers by max. 30 cm, crank drive	<input type="checkbox"/>	–
8 Additional fabric support	–	<input type="checkbox"/>
Attachment		
Wall attachment + 2 front uprights <i>(wall brackets, base consoles included)</i>	■	■
additional/further attachment materials	<input type="checkbox"/>	<input type="checkbox"/>

Note

Due to the design and the weight of the awning fabric, the fabric may sag in the middle on large awning sizes. However, this has no effect on the operation and / or service life of the awning.

Possible dimensions and restrictions along with the complete range of electronic accessories can be found in the technical data in the current Lewens price list.

■ Standard Option – not available

Portofino Pergola type

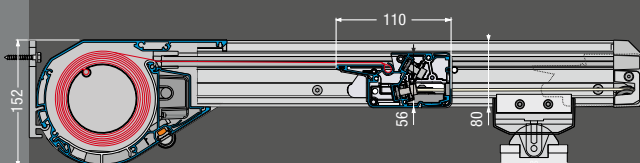

Capri Pergola type

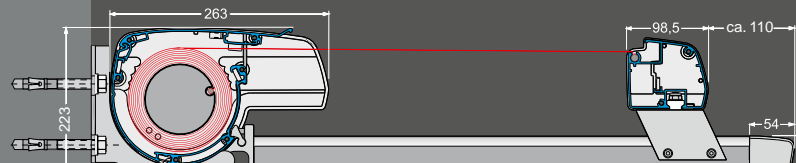

Side screen awning

Micro 700

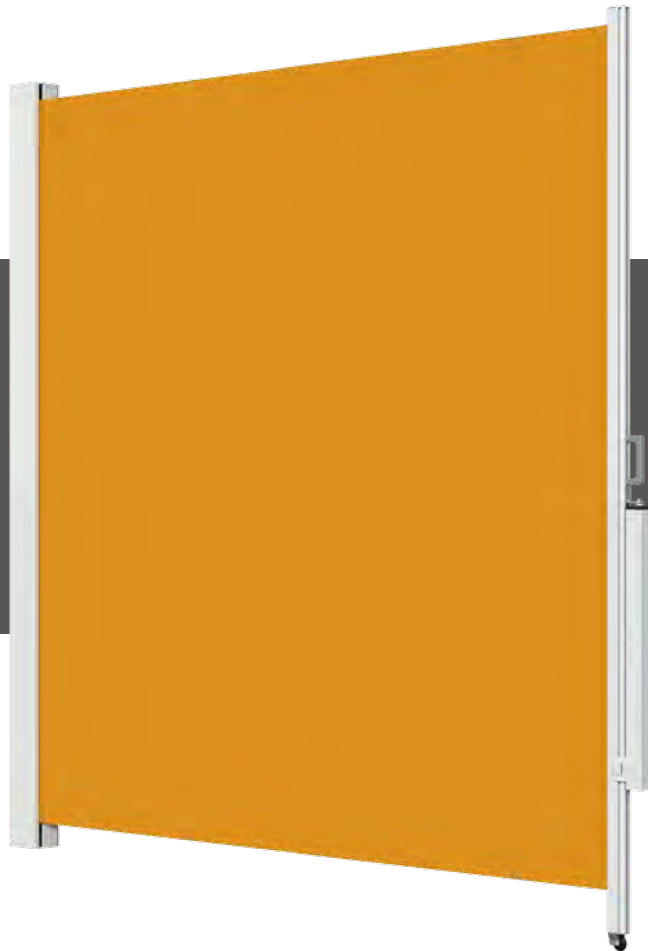

Type



Equipment

Side screen awning	
Wall cassette	
Screen height	up to max. 250 cm
Extension, depending on height and fabric	max. 400 cm
Attachment	
Wall bracket	<input checked="" type="checkbox"/>
Post	<input type="checkbox"/>
Drive	Manual operation <input checked="" type="checkbox"/>
Fabric	
Acrylic/Soltis 92	<input checked="" type="checkbox"/>
Polyester/recycled polyester	<input type="checkbox"/>



Standard Option

Options

- additional handles

Further information

can be found in the "Micro 700" brochure.



Installation
Wall mounting (standard)



Screwed to base
(instead of standard)



Screwed to base
with base console



www.lewens-markisen.de



Your stockist will be happy to advise you: