



Folding arm awnings

Trentino Mini
Trentino
Toscana Mini
Toscana
Toscana Grande



Full-cassette awnings

Just
enjoy life!

Lewens
MARKISEN

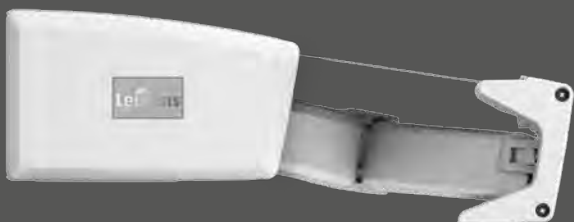



Successful sunshade products since 1998

Based in Ludwigslust, Lewens has been manufacturing high-quality awning and glass roof systems for 25 years. These range from simple to complex to meet every requirement.

The development of models and equipment options is influenced just as much by current trends as by the wishes and suggestions of specialist dealers and customers. This is how product series like the full cassette awnings featured here come into being: the Trentino and Toscana model families, both with an unmistakable appearance and unique shape, are characterised by their innovative design and high level of functionality.

Production takes place in a fully integrated operation - from the design and making up of the fabric to assembly – on a site covering over 30000 m². High-grade materials, well thought-out design and precision in cutting and parts production, together with computer-aided automation in the manufacturing process, form the basis for products distinguished by their extreme reliability.

Consultancy and sales are entrusted to competent retailers, along with installation and on-site servicing. This creates proximity to the customer and ensures optimal service, so that our customers can just enjoy life!



Quality "made in Germany":

*all awnings and glass roofs from Lewens
are manufactured in Germany.*



Just
enjoy life!



Trentino Mini



Trentino



Toscana Mini



Toscana



Toscana Grande

Contents

Models

Trentino Mini	4
The small flat cassette	
Trentino	6
“Angular” or “Rounded” type	
Toscana Mini	8
The small round cassette	
Toscana	10
A modern classic	
Toscana Grande	12
Large-scale shade	

Equipment

Quality and technology	14
Focus on function and workmanship	
Comfort options	16
Vario Valance, electrics and wireless	
Fabrics and colours	18
Fabric collection and choice of frame colours	
Technical data	20
at a glance	

To match

Micro 700	22
Side screen awning	



Comfort on a small scale

- Width max. 450 cm,
drop max. 250 cm
- Snug wall fitting
- Cassette H 11.8 x D 20.9 cm
- Electric motor
- Options:
Radio motor/
radio remote control,
automatic weather sensor,
LED lighting,
support legs



Trentino Mini – the small flat cassette

Full-cassette awning for balconies and small outdoor seating areas

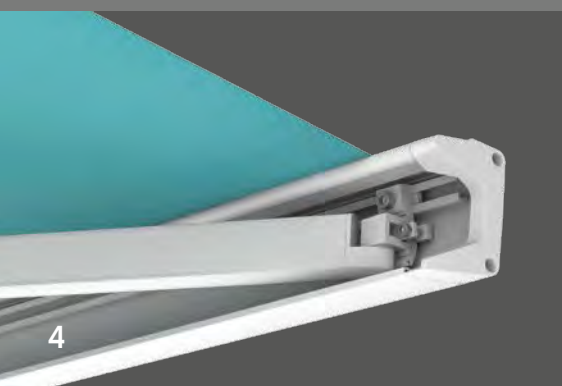

Function enhanced by design
– the connection of folding arms
to front profile

Elegance and stability
– the arm brackets

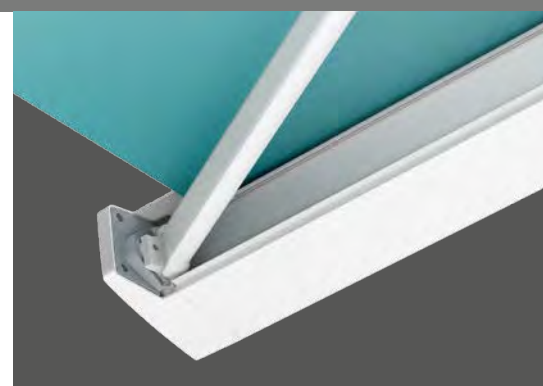



The **Trentino Mini** creates a snug seating area and adds a splash of colour to small patios.

The angular design of the Trentino Mini creates a particularly harmonious combination with modern geometrical architecture and current trends. Like the large models in the Trentino family, the Trentino Mini offers a high level of comfort and superior quality standard. It can be equipped with a variety of optional extras.



Full cassette

Enclosed all around and measuring just 11.8 cm in height, the cassette reliably protects the awning from the effects of the weather.



*Vario Valance (option, see fig. right)
The Vario Valance offers variable shade
from the sun and glare protection,
especially when the sun is low in the sky,
without any loss of headroom
under the awning.*

Trentino – the flat cassette to suit every style

Full-cassette awning for large patios and outdoor seating areas



Angular type

*The clean shape of the angular front profile
creates a particularly harmonious
combination with modern façade design.*

Cassette: H 161 x D 261 mm

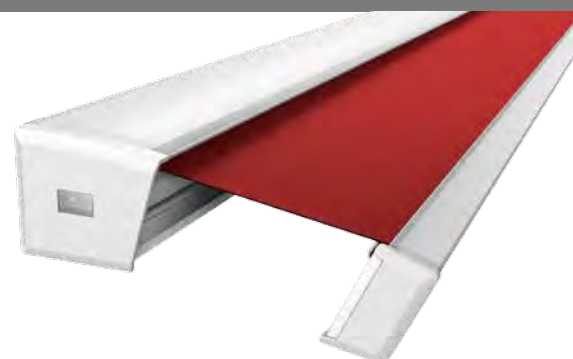

Equipment

- Width of single unit max. 700 cm, joined system max. 1.950 cm, drop max. 400 cm
- Snug wall fitting
- Electric motor
- Options:
Radio motor/
radio remote control,
automatic weather sensor,
LED lighting,
radiant heater,
support legs,
Vario Valance (Angular type)



Trentino Rounded

With its rounded front profile this awning type blends harmoniously into the façade of traditional classic architecture.



The Angular and Rounded model variants of the Trentino full-cassette awning offer versatile design options for large patios and balconies. The Angular type with its linear, angular front profile forms the perfect complement to modern geometrical architecture, while the design of the Trentino Rounded model was developed with classical construction styles in mind.

Rounded type

The rounded front profile with its soft contours sets the right tone for traditional construction forms.

Cassette: H 161 x D 252 mm

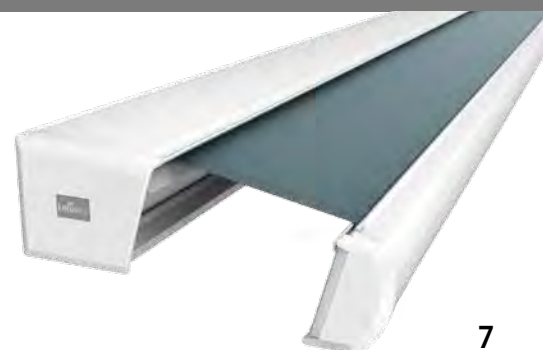



Toscana Mini – the small round cassette

Space-saving elegance for balcony and loggia



Attachment

The awning is delivered optionally with brackets facing to the rear (for wall mounting) or upwards (for ceiling mounting). The brackets are located on the outside of the awning in the area of the arm brackets.



Compact yet classy

- Width max. 450 cm, drop max. 250 cm
- Electric motor
- Options:
Radio motor/
radio remote control,
automatic weather sensor,
LED lighting,
support legs



Shade and privacy

Due to the special design of the Toscana Mini, a larger pitch angle can be set during assembly:

Possible pitch angles::

Mounting	Wall	Ceiling
Motor drive	5 - 60 °	5 - 60 °
Crank drive	5 - 27 °	5 - 60 °

Developed especially for small balconies and areas of shallow depth, the Toscana Mini awning boasts sophisticated technical details and comfort options.

The smallest full-cassette awning in the Toscana series turns even the smallest balcony into a favourite bolt-hole to relax in. The design of the Toscana Mini permits a steep pitch angle on installation, meaning that it offers privacy and shade even when the sun is low in the sky.



Full cassette

The compact cassette, just 10.5 cm high, protects the awning fabric reliably against the effects of the weather when closed.

Mounted on the wall or below the ceiling, the Toscana awning creates a light, floating impression.

The wide range of awning fabrics from the Lewens collection and choice of frame colours create endless combination and design possibilities.



Toscana – playful airiness

A classic for balconies and medium-sized patios



Attachment

The awning is supplied optionally with brackets facing to the rear (for wall mounting) or upwards (for ceiling mounting). The brackets are located on the outside of the awning in the area of the arm brackets.



Equipment and extras

- Width max. 600 cm,
drop max. 300 cm
- Electric motor
- Options:
radio motor/radio remote control,
automatic weather sensor,
LED lighting,
support legs

Shade and privacy

Due to the special design of the Toscana, a larger pitch angle can be set during assembly.

The awning thus offers privacy and shade even when the sun is low in the sky

Possible pitch angles:

Mounting	Wall/Ceiling
Motor drive	5 - 80 °
Crank drive	5 - 45 °



As an award-winning classic design from the house of Lewens, the Toscana embodies timeless elegance and adds a stylish touch to any balcony or patio. A particular highlight is that the Toscana can be fitted with an especially large pitch angle, thereby creating additional shade and privacy.



Full cassette

The 13 cm high cassette protects the awning reliably against the effects of the weather when retracted.



Toscana Grande – large-scale shade

The ultimate in comfort for large patios



Full cassette

When the awning is retracted, the front profile closes the cassette completely, protecting both fabric and mechanism reliably from the effects of the weather.



Equipment options to increase the comfort

- Width, 1 unit, max. 700 cm, joined system max. 1950 cm, drop max. 400 cm
- Electric motor
- Options:
Radio motor/radio remote control,
automatic weather sensor,
LED lighting
radiant heater,
support legs,
Vario Valance



Lightness on a grand scale

Up to a width of 650 cm, the Toscana Grande is attached to wall or ceiling using just two brackets (illustration on the left).

The bracket attachment is variable thanks to specially developed casing holders, which permit a lateral tolerance on installation

Vario Valance (option)

The Vario Valance offers variable shade from the sun and glare protection, especially when the sun is low in the sky, without any loss of headroom under the awning.

The biggest full-cassette awning in the Toscana series with a self-supporting, oval casing presents a convincing combination of compactness and elegance and is especially suitable for large patios. When mounted on wall, ceiling or rafters, the Toscana Grande appears to float, radiating a notable lightness, even in large formats or as a joined system.



Privacy

The optional Vario Valance also guards against unwanted attention from outside. If Soltis woven fabric is selected, the view outwards is retained.





Quality and technology made in Germany

Thanks to their clean design, quality and a variety of equipment options, full-cassette awnings from Lewens make a convincing impression. Centimetre-accurate manufacturing, even in intermediate sizes, ensures a perfect fit in virtually any desired location.



Full-cassette awnings are folding arm awnings with a self-supporting casing.
They are therefore especially compact and space-saving.
Enclosed all round, they protect the retracted awning and mechanism reliably from the effects of the weather.

Durable and robust:

Arm bracket of high-strength aluminium alloy, upper arm fork of forged aluminium.

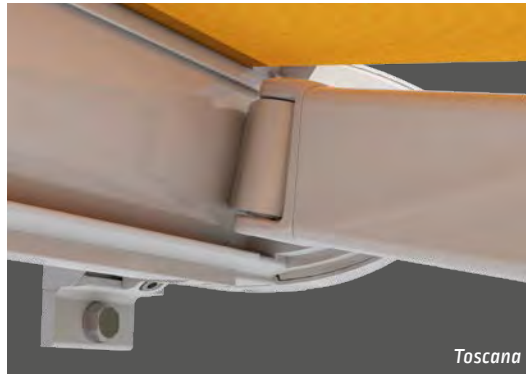

Toscana



Toscana

The **front profile bracket** connects the arms securely to the front profile.

Central folding arm joints

A plastic sheath prevents soiling and corrosion of the double cable in the central folding arm joints and extends its service life.

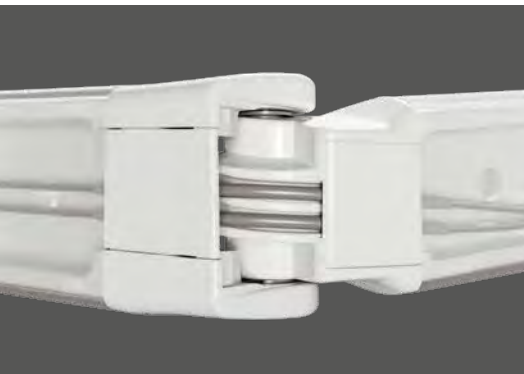
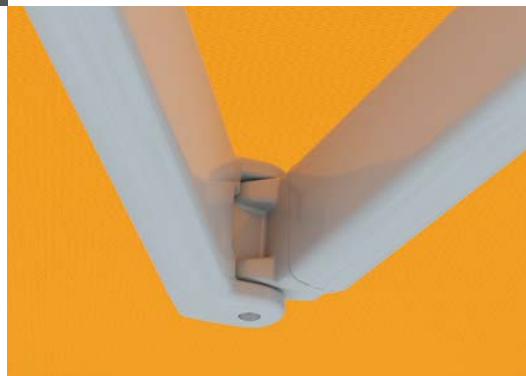

All double cables are greased for improved running with less friction.

The axle pins of the hinges consist of stainless steel.

The extremely high **spring tension** of the folding arms guarantees a superbly taut sit of the fabric and largely prevents the awning fabric from resting on the arm hinges.



Guaranteed quality



TÜV-tested quality and CE standard:

Look out for the seal and the mark guaranteeing the technical safety of our products.



Branded goods from Germany:

Lewens awnings are manufactured and assembled in Germany – quality "made in Germany"!

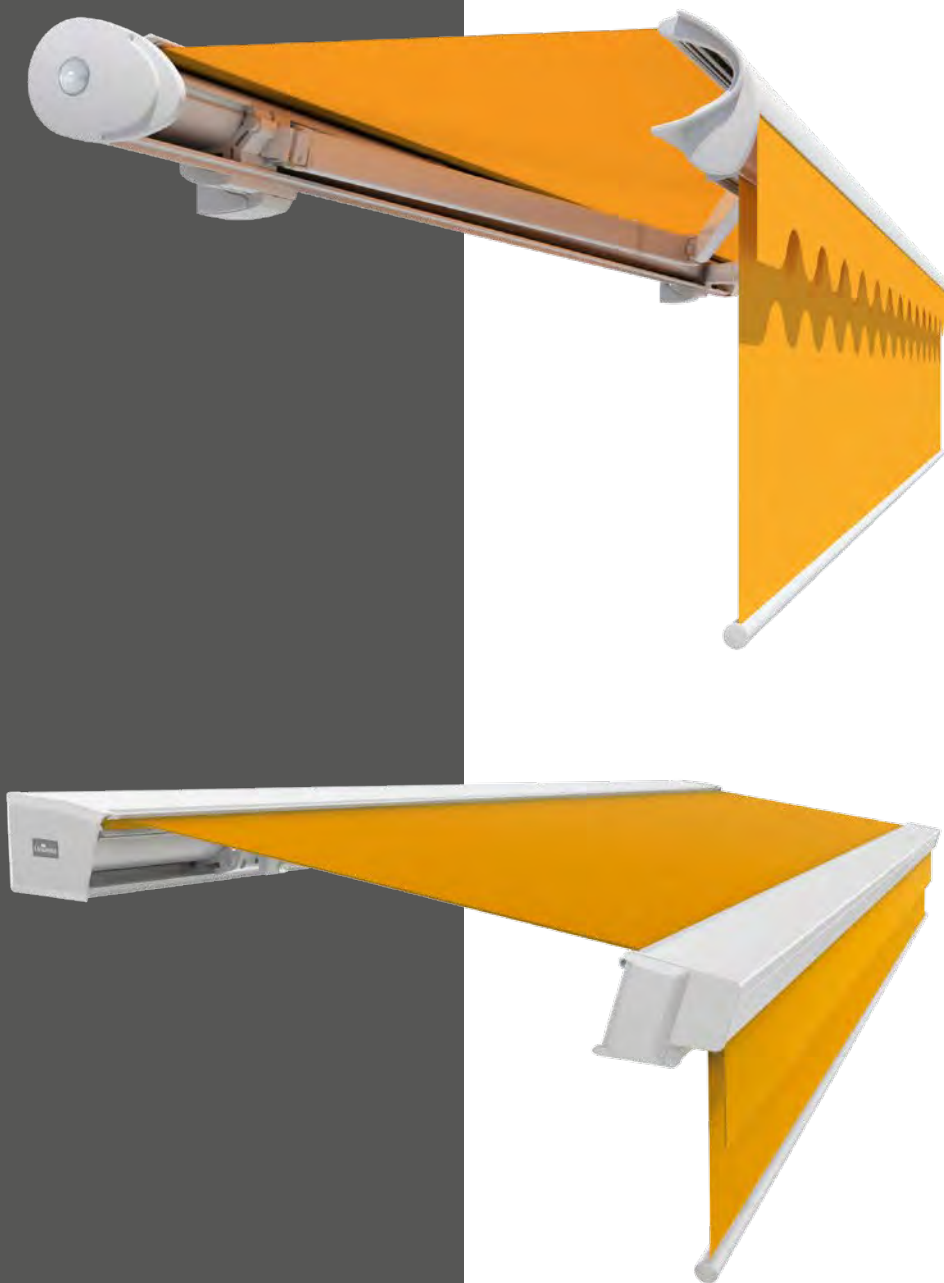

Models

- Toscana Grande
- Trentino

Standard equipment

- Supplied as standard with crank operation and acrylic awning fabric
- Hanging heights: 150 and 175 cm
- Always with additional short valance

For awnings up to a max. width of 600 cm

- Max. drop of 350 cm possible up to 500 cm width,
- Max. drop of 300 cm possible up to 550 cm in width and of 588 (Trentino)/589 (Toscana Grande) up to 600 cm width (3 arms!)
- Difference between width and drop min. 100 cm

Extras *[surcharge]*

- Polyester fabric (valance lengths 150 and 175 cm), Soltis 92 (valance length approx. 160 cm), Orchestra MAX (valance length 150 cm)
- Vario valance with radio-controlled motor (only for awnings with radio-controlled motor); valance length then 150 cm in acrylic/polyester, 160 cm in Soltis 92, 120 cm in Orchestra MAX

Not in connection with radiant heater.

Vario Valance Option

The Vario Valance offers variable shade and privacy while retaining the headroom below the awning. When the awning is retracted, the Vario Valance can also be used as a window blind, creating shade and a cool climate inside.

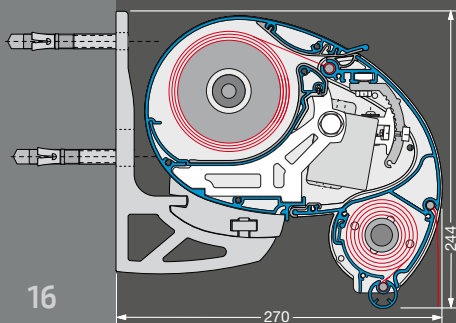

Toscana Grande
with Vario Valance option

Trentino
with Vario Valance option

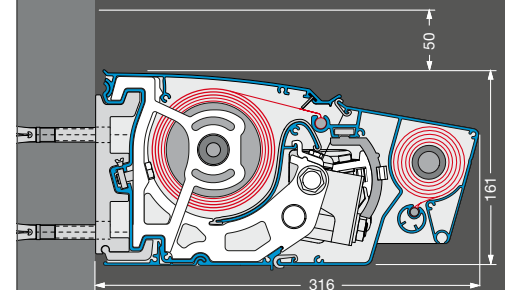



Radio controllers

create the prerequisites for integrating all patio functions into the home automation system, with convenient operation by tablet or smartphone.



Automatic weather sensor

Sun, wind and rain sensors ensure automatic, weather-dependent control of awnings – even when there's no one at home.

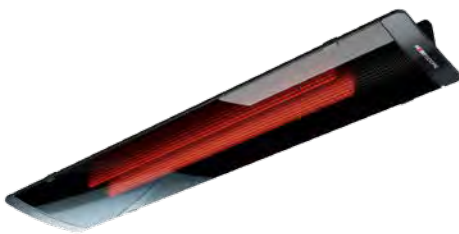

Infrared radiant heaters

create a cosy atmosphere and pleasant warmth under awnings and glass roofs, even on chilly days.

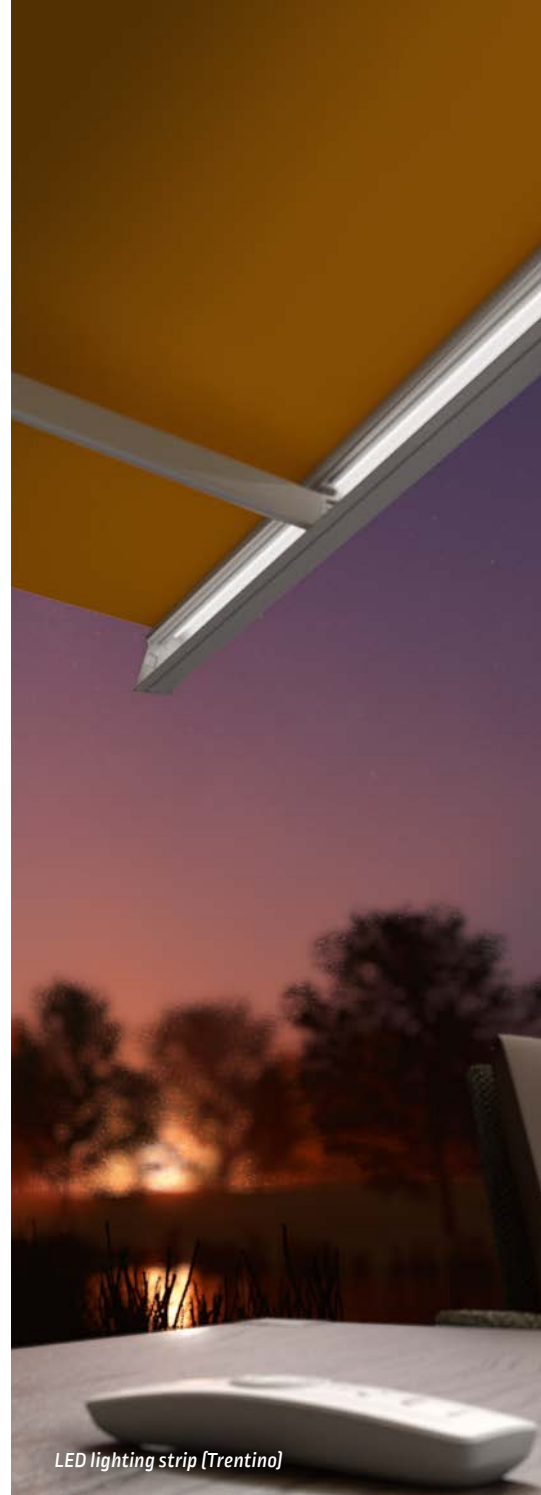

LED lighting strip [Trentino]

Options

Electrical

Want more than the wall switch for operation and other comfort features too? Then you have the choice of radio control systems, lighting, radiant heater and automatic weather sensor components meeting the contemporary standard, which can all be integrated into the home automation system. All patio functions can thus be conveniently operated via tablet or smartphone.



LED spot bar [Toscana Grande]

LED lighting

Equipped with a radio receiver, suitable mood lighting for any situation can be created by remote control or via the home automation system.



LED lighting strip [Toscana]

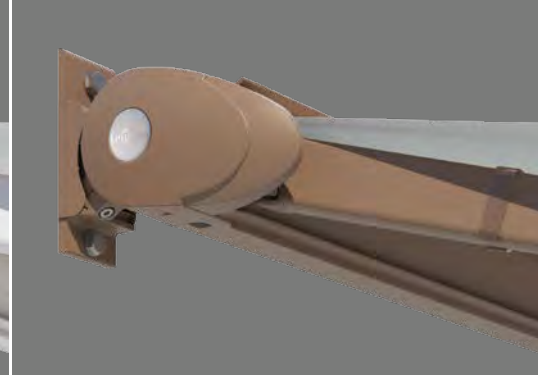
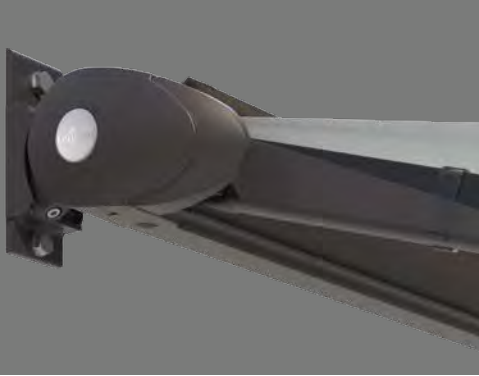

Standard colours: RAL colours and textured finishes (SL) **at no extra charge**



Colour differences may result from the printing process. We strongly recommend a comparison with our original colour samples.

Frame colours to order

The frames of Lewens awnings and glass roofs are given a high-grade powder coating, rendering them particularly UV- and weather-resistant. An optional preanodising treatment increases the durability of the coating for products used in coastal regions. Hundreds of RAL colours and textured finishes (SL) are available to choose from, including a wide range of contemporary colours offered as standard at no extra charge.



As well as powder-coated finishes, the frames of nearly all models are also offered in **natural silver**.
Finish: frame in **E6/EV1 silver anodised**, small components such as hinge parts, brackets etc. powder-coated in silver RAL 9006.



The Lewens collection offers you high-quality acrylic and polyester fabrics that are solution-dyed to retain their colour brilliance for longer, wovens containing 85% recycled polyester from PET bottles as well as partly transparent glass fibre screen fabrics and Soltis 92.

Lewens awning fabrics have been created especially for use outdoors and are treated to make them water- and dirt-repellent. We make the awnings up using the latest sewing techniques for distortion-free seams and also using ultrasonic bonding. We have designed our manufacturing facility so that the awning fabrics can be laid out entirely flat (not folded) for making up.

Some of our quality features:

- Secure lockstitch used for making up, optionally also with ultrasonically bonded seam (surcharge).
- Awning and valance are produced from one piece (identical repeat pattern)
- Seams on top and bottom and valance seam neatened (clean completion)
- Repeat-symmetrical completion left and right
- Use of Tenara® quality sewing yarn (also for valances)

The Collection

Fabrics ranging
from modern to classic

Valance styles



Style 1



Style 2



Style 3



Style 4

Trentino

Equipment and technical features



Manufactured and assembled in Germany
TÜV-tested safety
Quality and technology CE-compliant



Trentino Mini



Trentino



Trentino

Type		Angular	Rounded
Full cassette, flat cassette (H x D)	118 x 209 mm	161 x 261 mm	161 x 252 mm
Widths (max.)			
1 unit (single panel)	450 cm	700 cm	700 cm
2 units/3 units (joined system with slit cover)	-	1.300 / 1.950 cm	1.300 / 1.950 cm
Drops			
Arm lengths 150 / 200 / 250 cm	■	■	■
Arm lengths 300 / 350 / 400 cm	-	■	■
Special arm lengths	□	□	□
Drive			
Electric motor (for wall switch)	■	■	■
Radio motor	□	□	□
Crank drive	□	□	□
Frame colours			
29 Lewens standard frame colours	■	■	■
Natural silver (E6/EV 1 anodized, small components RAL 9006)	■	■	■
Additional RAL, special colours and effect finishes	□	□	□
Awning fabrics from the LEWENS collection			
Branded acrylic (spun-dyed, ultra fade resistant)	■	■	■
Branded polyester/recycled polyester (spun-dyed, ultra fade resistant)	□	□	□
Orchestra MAX (branded acrylic, water repellent), up to 600 x 350 cm	□	□	□
Tenara quality sewing yarn	■	■	■
Ultrasonic seam welding	□	□	□
Valance			
without valance	■	■	■
with valance	-	□	□
Options			
1 Radio motor + radio remote control	□	□	□
2 Automatic weather sensor (sun, wind, rain)	□	□	□
3 Lighting – LED lighting strip under cassette	□	-	-
– LED spot bar under cassette	-	□	□
– LED lighting strip in front profile	-	□	□
4 Radiant heater (not with 6; with 3 only wall attachment)	[* □]	□	□
5 Support legs (not with 2)	□	□	□
6 Vario Valance, up to 500 x 350 cm, 501-550/588-600 x 300 cm (not with 4)	-	□	-
Attachment			
Wall	■	■	■
Ceiling	□	□	□
Rafters	□	□	□

Possible dimensions and restrictions along with the complete range of electronic accessories can be found in the technical data in the current Lewens price list.

■ Standard □ Option – not available
* only wall attachment

Trentino Mini

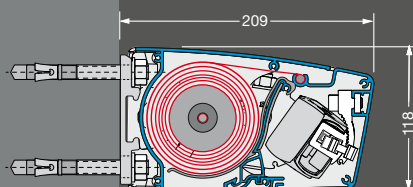

Trentino Angular type

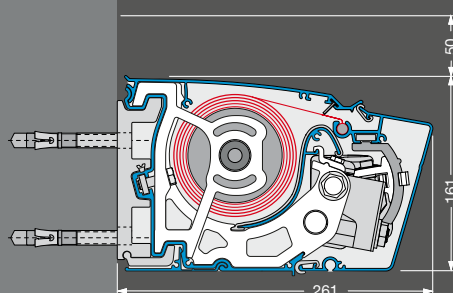

Trentino Rounded type

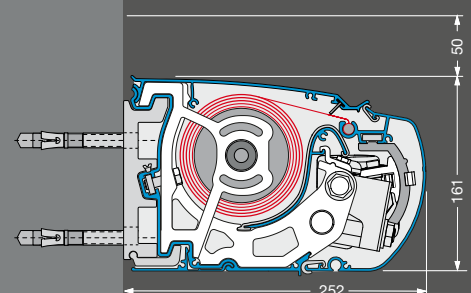

Toscana

Equipment and technical features



Manufactured and assembled in Germany
TUV-tested safety
Quality and technology CE-compliant



Toscana Mini



Toscana



Toscana Grande

Full cassette (H x D)	105 x 185,5 mm	130 x 223 mm	157 x 239 mm
Widths (max.)			
1 unit (single panel)	450 cm	600 cm	700 cm
2 units/3 units (joined system with slit cover)	–	–	1.300 / 1.950 cm
Drops			
Arm lengths 150 / 200 / 250 cm	■	■	■
Arm lengths 300 cm	–	■	■
Arm lengths 350 / 400 cm	–	–	■
Special arm lengths	□	□	□
Drive			
Electric motor (for wall switch)	■	■	■
Radio motor	□	□	□
Crank drive	□	□	□
Frame colours			
29 Lewens standard frame colours	■	■	■
Natural silver (E6/EV 1 anodized, small components RAL 9006)	■	■	■
Additional RAL, special colours and effect finishes	□	□	□
Awning fabrics from the LEWENS collection			
Branded acrylic (spun-dyed, ultra fade resistant)	■	■	■
Branded polyester/recycled polyester (spun-dyed, ultra fade resistant)	□	□	□
Orchestra MAX (branded acrylic, water repellent), up to 600 x 350 cm	□	□	□
Tenara quality sewing yarn	■	■	■
Ultrasonic seam welding	□	□	□
Valance			
without valance	■	■	■
with valance	□	□	□
Optionen			
1 Radio motor + radio remote control	□	□	□
2 Automatic weather sensor (sun, wind, rain)	□	□	□
3 Lighting – LED lighting strip under cassette	□	□	–
– LED spot bar under cassette	–	–	□
4 Radiant heater (not with 6; with 3 only wall attachment)	[* □]	[* □]	□
5 Support legs (not with 2)	□	□	□
6 Vario Valance, up to 500 x 350 cm, 501-550/589-600 x 300 cm (not with 4)	–	–	□
Attachment			
Wall	■	■	■
Ceiling	■	■	□
Rafters	□	□	□

Possible dimensions and restrictions along with the complete range of electronic accessories can be found in the technical data in the current Lewens price list.

■ Standard □ Option – not available
* only wall attachment

Toscana Mini

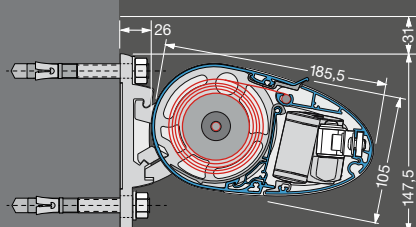

Toscana

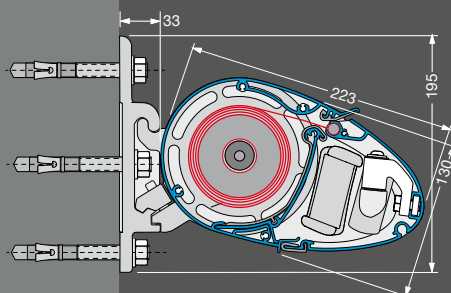

Toscana Grande

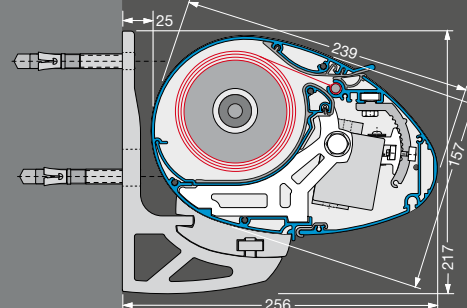

TO MATCH:



Micro 700 – side screen awning

The perfect complement to the folding arm awning

*The Micro 700 is simply extended using the **handle** (position and number optional) and hooked onto the wall mounting or post.*

*The **bottom castor** enables the awning to be guided easily. The awning shaft is fitted with an anti-kickback brake for safe, convenient operation.*



Wall cassette (W x D)	108,8 x 100,6 mm		
Unit height (max.)			
1 unit (single panel)	250 cm		
Extension (max., depending on fabric and height)	Height up to 134 cm	Up to 190 cm	Up to 250 cm
Acrylic/(recycled) polyester	400 cm	*300 cm	*300 cm
Soltis 92	400 cm	400 cm	*300 cm
Drive			
Manual operation, 1 handle	<input checked="" type="checkbox"/>		
Manual operation, further handles	<input type="checkbox"/>		
Frame colours			
29 Lewens standard frame colours	<input checked="" type="checkbox"/>		
Additional RAL, special colours and effect finishes	<input type="checkbox"/>		
Awning fabrics from the LEWENS collection			
Branded acrylic (spun-dyed, ultra fade resistant)	<input checked="" type="checkbox"/>		
Soltis 92	<input checked="" type="checkbox"/>		
Branded polyester/recycled polyester (spun-dyed, ultra fade resistant)	<input type="checkbox"/>		
Tenara quality sewing yarn	<input checked="" type="checkbox"/>		
Ultrasonic seam welding	<input type="checkbox"/>		

Possible dimensions and restrictions along with complete range of accessories can be found in the technical data in the current Lewens price list.

Standard Option
* only with vertical run

The Micro 700 side screen awning provides shelter from the sun, wind and unwanted attention, creating a snug refuge on the patio, balcony or loggia. The Micro 700 complements the conventional sunshade in terms of function and design. The fabrics of all Lewens products can be perfectly coordinated with one another.

When the awning is retracted, the cassette can simply be removed from the bracket to prevent theft or vandalism and can be stored safely until it is next used.

Installation

Wall mounting (standard)



Screwed to base

(instead of standard)



Screwed to base

with base console





www.lewens-markisen.de



Your stockist will be happy to advise you: